



Order Code

UC4000-30GM-E6R2-V15

Features

- Parameterisation interface for the application-specific adjustment of the sensor setting via the service program ULTRA 3000
- 2 switch outputs freely adjustable
- Hysteresis mode selectable
- Window function can be selected
- Synchronisation options
- Adjustable acoustic power and sensitivity
- Temperature compensation

Electrical Connection

Standard symbol/Connection:
(version E6, pnp)

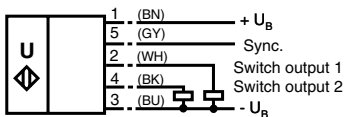

Core colours in accordance with EN 60947-5-2.

Connector V15



Dimensions

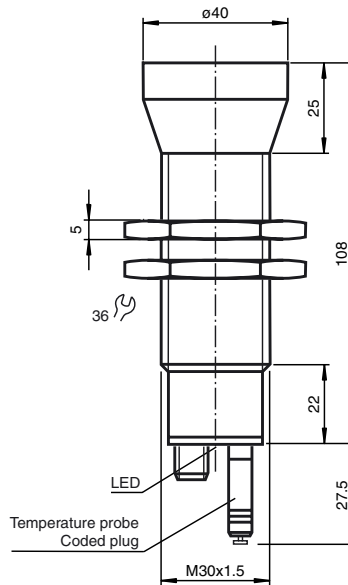

Technical Data

General specifications

Sensing range	200 ... 4000 mm
Adjustment range	240 ... 4000 mm
Unusable area	0 ... 200 mm
Standard target plate	100 mm x 100 mm
Transducer frequency	approx. 85 kHz
Response delay	145 ms minimum 440 ms factory setting

Indicators/operating means

LED green	permanent: Power-on flashing: Standby mode or TEACH-IN function object detected
LED yellow 1	permanent: switching state switch output 1 flashing: TEACH-IN function
LED yellow 2	permanent: switching state switch output 2 flashing: TEACH-IN function
LED red	permanent: temperature/TEACH-IN plug not connected flashing: fault or TEACH-IN function object not detected
Temperature/TEACH-IN connector	temperature compensation, TEACH-IN of the switch points, output function setting

Electrical specifications

Operating voltage U_B	10 ... 30 V DC, ripple 10 % _{SS}
No-load supply current I_0	≤ 50 mA

Interface

Interface type	RS 232, 9600 Bit/s, no parity, 8 data bits, 1 stop bit
----------------	--

Input/output

Synchronisation	bi-directional 0 level: $-U_B \dots +1$ V 1 level: $+4$ V ... $+U_B$ input impedance: > 12 KOhm synchronisation pulse: ≥ 100 μs, synchronisation interpulse period: ≥ 2 ms
-----------------	--

Synchronisation frequency	Common mode operation ≤ 13 Hz Multiplex operation ≤ 13/n Hz, n = number of sensors
---------------------------	---

Output

Output type	2 switch outputs pnp, NO/NC, parameterisable
Rated operational current I_e	200 mA, short-circuit/overload protected
Voltage drop U_d	≤ 2.5 V
Repeat accuracy	≤ 0.1 % of full-scale value
Switching frequency f	≤ 1 Hz
Range hysteresis H	1 % of the adjusted operating range (default settings), programmable
Temperature influence	≤ 2 % from full-scale value (with temperature compensation) ≤ 0.2 %/K (without temperature compensation)

Standard conformity

Standards	EN 60947-5-2
-----------	--------------

Ambient conditions

Ambient temperature	-25 ... 70 °C (248 ... 343 K)
Storage temperature	-40 ... 85 °C (233 ... 358 K)

Mechanical specifications

Protection degree	IP65
Connection	connector V15 (M12 x 1), 5 pin
Material	
Housing	stainless steel 1.4303 plastic parts PBT
Transducer	epoxy resin/hollow glass sphere mixture; polyurethane foam
Mass	180 g

Description of the sensor functions

This ultrasonic sensor features a four-pole temperature/Programming plug that can be inserted in four different positions. These have the following function.

Plug position	Function
A1	TEACH-IN switch point A1
A2	TEACH-IN switch point A2
E2/E3	Switching: 2 independent switch points/window mode/latching mode
T	Temperature compensation

Description of the Programming procedure

Programming switch points 1 or 2

- Disconnect supply voltage
- Remove the PROGRAMMING plug to activate program mode.
- Reconnect supply voltage (Reset)
- Place the target at the desired switch point position (A1 or A2)
- Momentarily insert the programming plug in the desired position for configuring the switch point, A1 or A2, and then remove. This will program the selected switch point.

Caution: Removing the PROGRAMMING plug saves the new switch point position into the device memory.

- The PROGRAMMING status is indicated by the LED. A flashing green LED indicates that the target is detected; a flashing red LED indicates that no target is detected.
- Insert the PROGRAMMING plug in position T. This completes the PROGRAMMING procedure and saves the switch point distance.
- The sensor now operates in normal mode.

Programming the operating mode

- Disconnect supply voltage
- Remove the Programming plug to activate the programming mode
- Reconnect the supply voltage (Reset)
- Insert the PROGRAMMING plug in position E2/E3. Now by removing and reinserting the plug, the user can toggle through the three different modes of operation. The selected mode is indicated by the LED's as shown below:
 - switch point mode, LED A1 flashes,
 - window mode, LED A2 flashes
 - latching mode, LED A1 and A2 flash
- Once the desired mode is selected, insert the PROGRAMMING plug in position T. This will complete the PROGRAMMING procedure and save the selected mode of operation.
- The sensor now operates in normal mode.

Note: The PROGRAMMING plug also functions as the temperature compensation. If the PROGRAMMING plug has not been inserted in the T position within 5 minutes, the sensor will return to normal operating mode with the latest saved values, without temperature compensation.

Synchronization

This sensor features a synchronization input for the possible suppression of ultrasonic mutual interference. If this input is not connected, the sensor will operate using internally generated clock pulses. It can be synchronized by applying an external square wave. The synchronization pulse falling edge triggers each transmission of a single ultrasonic pulse. If the synchronization signal remains low for ≥ 1 second, the sensor will revert to non-synchronized mode. Non-synchronized mode can also be activated by opening the signal connection to the synchronization input. (See note below)

If the synchronization input goes to a high level for > 1 second, the sensor will switch to standby mode, indicated by green LED. In this mode the outputs will remain in the last valid output state.

The synchronization function cannot be activated during programming mode and vice versa.

The following synchronization modes are possible:

1. Two to five sensors can be synchronized together by interconnecting their respective synchronization inputs. In this case each sensor alternately transmits ultrasonic pulses in a self multiplexing mode. No two sensors will transmit pulses at the same time.
2. Multiple sensors can be controlled by the same external synchronization signal. In this mode the sensors are triggered in parallel and are synchronized by a common external synchronization pulse.
3. A separate synchronization pulse can be sent to each individual sensor. In this mode the sensors operate in external multiplex mode.
4. A high level on the synchronization input disables the sensor.

Sensor response times will increase proportionally to the number of sensors that are in the synchronization string. This is a result of the multiplexing of the ultrasonic transmit and receive signal and the

Characteristic Curves/Additional Information

Characteristic response curve

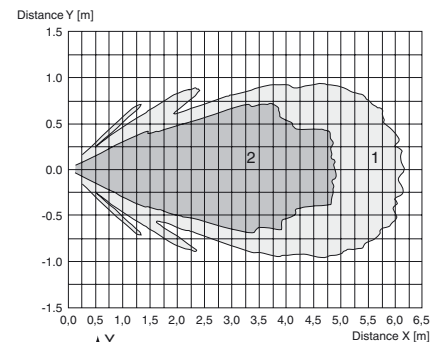

Curve 1: flat surface 100 mm x 100 mm
Curve 2: round bar, \varnothing 25 mm

Possible operating modes

1. Switch point mode

When $A1 < A2$, both switch outputs are activated as N.O. contacts.

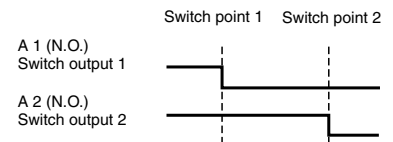

When $A1 > A2$, both switch outputs are activated as N.C. contacts.

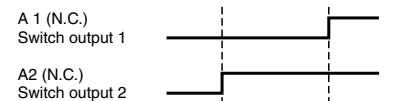

2. Window mode

To exchange the switching distances is of no effect.

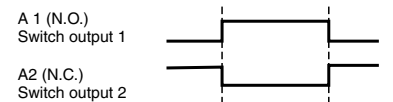

3. Hysteresis mode

To exchange the switching distances is of no effect.

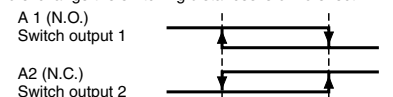

Accessories

BF 30
Mounting flange

BF 5-30
Mounting flange

UC-30GM-TEMP
Temperature sensor

UC-30GM-PROG
Accessories

ULTRA3000
Software for ultrasonic sensors, comfort line

UC-30GM-R2
Accessories

V15-G-2M-PVC
Cable connector

V15-W-2M-PUR
Cable connector

resulting increase in the measurement cycle time.

Note:

If the option for synchronization is not used, the synchronization input has to be connected to ground (0V) or the sensor has to be operated via a V1 cordset (4-pin).

Default setting

A1: unusable area

A2: nominal sensing range

LED Displays

Displays in dependence on operating mode	Dual LED green	LED red	LED yellow A1	LED yellow A2
Programming switch point A1 object detected no object detected	flashing off	off flashing	flashing flashing	off off
Programming switch point A2 object detected no object detected	flashing off	off flashing	off off	flashing flashing
Programming mode of operation (E2/E3) two independent switching points window mode Hysteresis mode	on on on	off off off	flashing off flashing	off flashing flashing
Normal mode temperature compensated plug pulled or shorted	on off	off on	switch state A1 switch state A1	switch state A2 switch state A2
Interference (e.g. compressed air)	off	flashing	last or defined condition	last or defined condition
Standby	flashes	off	previous state	previous state

LED ON indicates closed switch output.

LED-Window

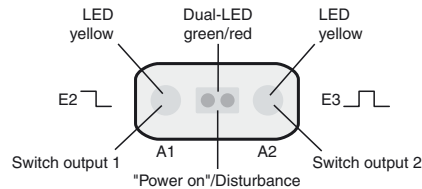

RS 232-connection

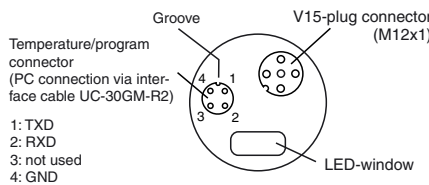

Note on communication with the UC-30GM-R2 interface cable

The UC-30GM-R2 interface cable allows for communication with the ultrasonic sensor using the ULTRA 3000 service program. The cable creates a connection between a PC RS-232 interface and the plug-in connection for the temperature/programming plug on the sensor. When connecting to the sensor, make certain the plug is lined up correctly; otherwise communication will not be possible. The key of the round plug must be inserted into the groove of the receptacle on the sensor side and not into the arrow symbol on the sensor.

Adjustable parameter with service program ULTRA 3000

- Switch point 1 and 2
- NO/NC function
- Mode of operation
- Sonic speed
- Temperature offset (The inherent temperature-rise of the sensor can be considered in the temperature compensation)
- Expansion of the unusable area (for suppression of unusable area echoes)
- Reduction of the detection range (for suppression of remote range echoes)
- Time of measuring cycle
- Acoustic power (interference of the burst duration)
- Sensitivity
- Behaviour of the sensor in case of echo loss
- Behaviour of the sensor in case of a fault
- Average formation via an allowed number of measuring cycles
- On/off-delay
- Switching hysteresis
- Selection of the parameter set, RS 232 or manually.