

Direct mounting on standard actuators
 Compact and stable housing
 Fixed setting
 Satisfies machinery directive

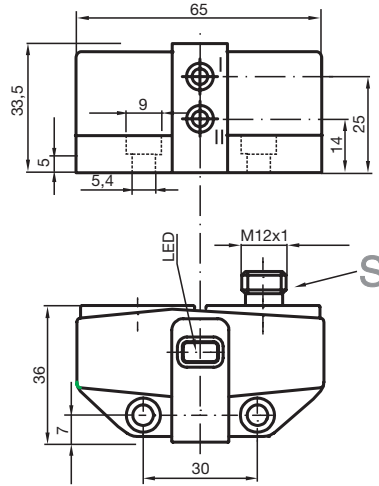

Switching element function	Binary NO
Rated operating distance s_n	3 mm
Installation	embeddable
Assured operating distance s_a	0 ... 2,43 mm
Reduction factor r_{AI}	0,5
Reduction factor r_{Cu}	0,4
Reduction factor r_{V2A}	1
Reduction factor r_{St37}	1,1
Operating voltage U_B	6 ... 60 V
Switching frequency f	0 ... 500 Hz
Hysteresis H	typ. 5 %
Reverse polarity protection	tolerant
Short circuit protection	no
Voltage drop U_d	≤ 6 V
Operating current I_L	4 ... 100 mA
Off-state current I_r	0 ... 1 mA typ. 0,7 mA
Indication of the switching state	LED, yellow
Tightening torque, fixing screws	0,4 Nm
EMC in accordance with	EN 60947-5-2
Standards	EN 60947-5-2
Ambient temperature	-25 ... 70 °C (248 ... 343 K)
Connection (system side)	V1-connector
Housing material	PBT
Sensing face	PBT
Protection degree	IP67

Connection_type:

Z8-V1

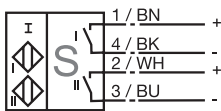

086528_ENG.xml

2003-03-21